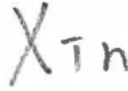

# APPROVAL SHEET

Customer Name : \_\_\_\_\_  
 Customer P/N : \_\_\_\_\_  
 Frequency : 16.000000 MHz  
 Aker Approved P/N: CXAF-016000-3-D4-06  
 Aker MPN : CXAF-016000-3-D4-06  
 Rev. : 1  
 ISSUE DATE : Feb.2.2023

APPROVED	CHECKED	PREPARED
		
APPROVED BY CUSTOMER		

## AKER TECHNOLOGY CO., LTD.

ADDRESS : NO 11-3, Jianguo Rd., Tanzi Dist., Taichung City 427, Taiwan.

TEL : 886-4-25335978 FAX : 886-4-25336011

Web: [www.aker.com.tw](http://www.aker.com.tw)

**MSL:Level 1**

**RoHS compliant**

**IATF 16949 Certified**

**AEC-Q200 Qualified**





Aker Approved P/N : CXAF-016000-3-D4-06	
APPROVED : Xtal	SHEET : 2 of 8
PREPARED : Xin	REV. : 1
Confidential	

## SMD CRYSTAL SPECIFICATION

### 1 . ELECTRICAL CHARACTERISTICS

■ Standard atmospheric conditions

Unless otherwise specified , the standard range of atmospheric conditions for making measurement and tests are as follow :

Ambient temperature : 25±5 °C

Relative humidity : 40%~70%

If there is any doubt about the results , measurement shall be made within the following limits :

Ambient temperature : 25±3 °C

Relative humidity : 40%~70%

- AKER Model : CXAF-321
- Oscillation Mode : Fundamental
- Cutting Mode : AT CUT
- Measurement Equipment : 250B(Measured FL)
- Insulation Resistance : More than 500M ohms at DC 100V

Parameters	Symbol	Electrical Spec				Notes
		Min.	Typ.	Max.	Units.	
Nominal Frequency	FL	16.000000			MHz	
Frequency Tolerance		±10			ppm	at 25°C ± 3°C
Frequency Stability		±30			ppm	Operating Temp (Refer 25°C)
Load Capacitance	CL	9			pF	
Aging		±3			ppm	First Year
Operating Temperature		-40	~	105	°C	
Storage Temperature Range		-55	~	150	°C	
Drive Level	DL			300	uW	
Equivalent Series Resistance	ESR			80	Ω	@Series
Shunt Capacitance	C0			3	pF	

\*Please kindly be noted that AKER DO NOT guarantee parts quality which involves human security application.\*

## 2 . MARKING :

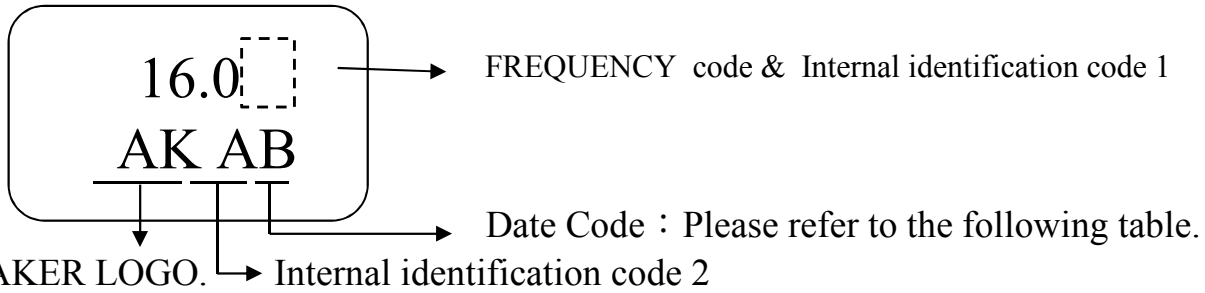

Date Code Table

Month / Year			1	2	3	4	5	6	7	8	9	10	11	12
2019	2023	(4N+3)	A	B	C	D	E	F	G	H	J	K	L	M
2020	2024	(4N+0)	N	P	Q	R	S	T	U	V	W	X	Y	Z
2021	2025	(4N+1)	a	b	c	d	e	f	g	h	j	k	l	m
2022	2026	(4N+2)	n	p	q	r	s	t	u	v	w	x	y	z

A cycle every four years

## 3 . DIMENSION :

( Unit : mm )



#### 4. STRUCTURE ILLUSTRATION



COMPONENTS		MATERIALS	COMPONENTS		MATERIALS
A	Base (Package)	Ceramic( $Al_2O_3$ )+Kovar(Fe/Co/Ni)	D	Electrode	Cr / Ag
B	Conductive adhesive	Ag / Silicon resin	E	Lid	Fe/Co/Ni
C	Crystal blank	$SiO_2$			

**5. PACKING :**

**TAPE SPECIFICATION**

( Unit : mm )



**OUTLINE DIMENSION**

( Unit : mm )

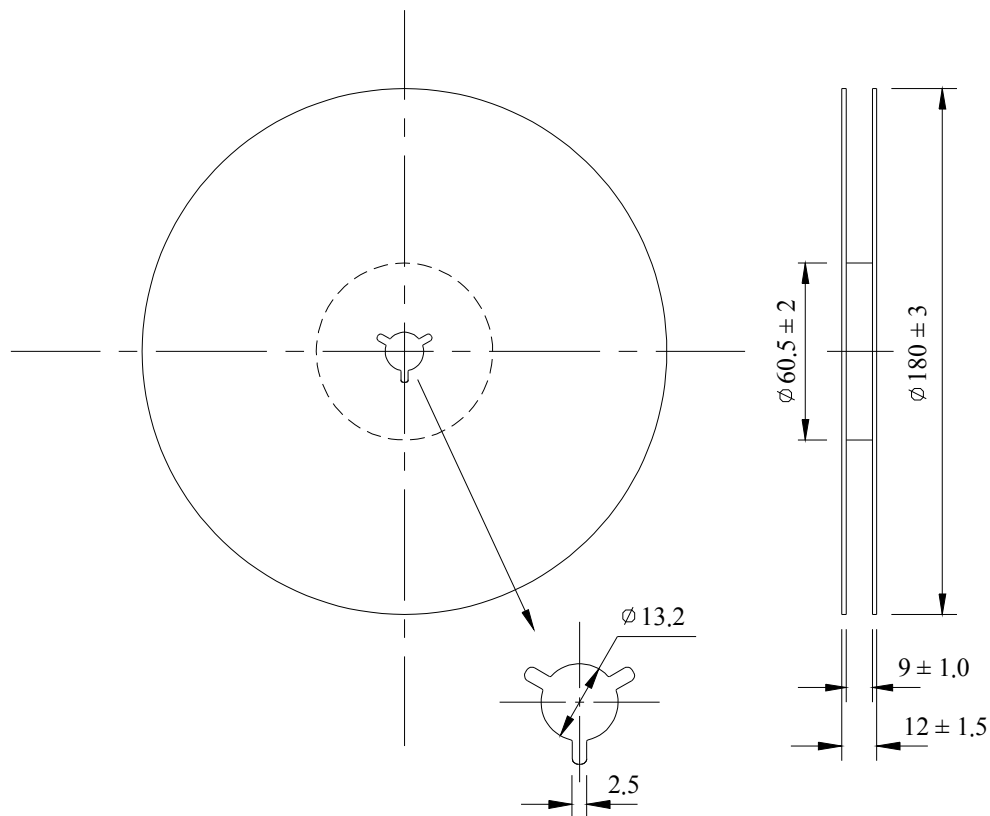

## 6. COVER TAPE ADHESION STRENGTH :



\*\*\* In the case, the cover tape is pulled off under the above conditions, the cover tape adhesion strength should be 10.2g~71.4g      Plastic tape: 10.2g~71.4g

(Cover tape adhesion strength)

## 7. SOLDERING REFLOW PROFILE



**8. PACKING :**

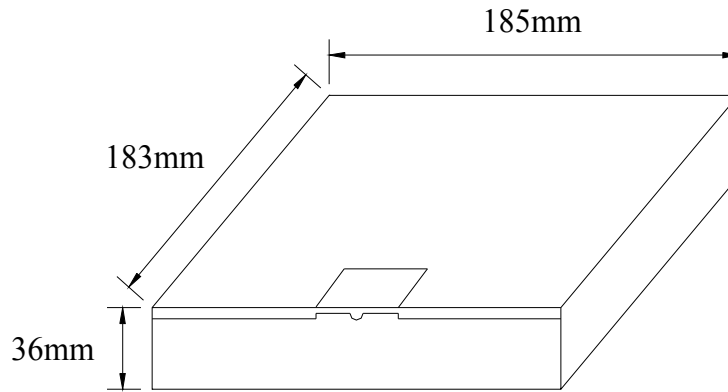

BOX = 3000 PCS / REEL(MAX)



SMD product packs 32 BOX=The outside box packs (3000 PCS \*32 BOX = 96000 PCS)(MAX)





Aker Approved P/N : CXAF-016000-3-D4-06

APPROVED : Xtal SHEET : 8 of 8

PREPARED : Xin REV . : 1

Confidential

## 9 . MECHANICAL PERFORMANCE

TEST ITEMS	TEST METHODS AND TEST CONDITION	PERFORMANCE
9.1 Temperature Cycling	-55±3°C/30min maximum~+125±3°C/30min maximum , 1000cycles	To satisfy the electrical performance .
9.2 Operational Life	125°C±3°C , 1000hrs±12hrs	
9.3 Biased Humidity	85°C±5°C&85%±5%R.H. , 1000±12hrs	
9.4 Resistance To Soldering Heat Test	Reflow test 2 times.	
9.5 High Temperature Exposure	150°C±3°C , 1000hrs±12hrs	
9.6 Vibration Test	Freq.range: 10~2000Hz , Peak to peak amplitude:1.52mm Peak acceleration:5G (49m/s <sup>2</sup> ) , 3 direction(X, Y,Z) , 20min 12cycles each of 3 orientations.	
9.7 Mechanical Shock	100G , 6mS , 3 times for each direction(X, Y, Z ) , 3 cycles	
9.8 Physical Dimension	Verify physical dimensions to the applicable device detail specification.	
9.9 Solderability	260°C , Coated > 95%	
9.10 Board Flex	PCB=100*40(mm) , Bending=2 mm (min) , Duration=60+5/-0 sec	
9.11 External Visual	Inspect device construction and marking.	
9.12 Terminal Strength	A force of 17.7N for 60 seconds.	