

APPROVAL SHEET

Customer Name : _____
 Customer P/N : _____
 Frequency : 24.576000 MHz
 Aker Approved P/N : SMAF-024576-A-D4-00
 Aker MPN : SMAF-024576-A-D4-00
 Rev. : 1
 ISSUE DATE : Feb.10.2023

APPROVED	CHECKED	PREPARED
<i>Lee</i>		<i>Xin</i>
APPROVED BY CUSTOMER		

AKER TECHNOLOGY CO., LTD.

ADDRESS : NO 11-3, Jianguo Rd., Tanzi Dist., Taichung City 427, Taiwan.

TEL : 886-4-25335978 FAX : 886-4-25336011

Web: www.aker.com.tw

MSL:Level 1

RoHS Compliant

IATF 16949 Certified

AEC-Q200 Qualified



Aker Approved P/N :	SMAF-024576-A-D4-00		
APPROVED :	Xtal	SHEET : 2 of 9	
PREPARED :	Xin	REV. : 1	
Confidential			

SMD CRYSTAL OSCILLATOR

1. ELECTRICAL CHARACTERISTICS

■ Standard atmospheric conditions

Unless otherwise specified, the standard range of atmospheric conditions for making measurement and tests are as follow :

Ambient temperature : 25±5 °C

Relative humidity : 40%~70%

If there is any doubt about the results, measurement shall be made within the following limits :

Ambient temperature : 25±3 °C

Relative humidity : 40%~70%

■ AKER Model : SMAF-211

■ Cutting Mode : AT CUT

Parameters	Symbol	Electrical Spec				Notes
		Min.	Typ.	Max.	Units.	
Nominal Frequency		24.576000			MHz	
Frequency Stability		±50			ppm	
Supply Voltage	V _{CC}	1.62	~	3.63	V	
Output Load CMOS	CL			15	pF	
Aging		±3			ppm	First Year
Enable Control		Yes				Pad 1
Operating Temperature		-40	25	85	°C	
Storage Temperature Range		-55	~	150	°C	
Output Voltage High	V _{OH}	90%V _{DD}			V	
Output Voltage Low	V _{OL}			10%V _{DD}	V	
Input Current	I _{CC}			7	mA	
Standby Current	I _{ST}			10	μA	
Rise Time	T _r			5	ns	10%~90%V _{DD} Level
Fall Time	T _f			5	ns	90%~10%V _{DD} Level
Symmetry (Duty ratio)	TH/T	45	~	55	%	
Start-up Time	T _{OSC}			10	ms	
Enable Voltage High	V _{HI}	70%V _{DD}			V	
Disable Voltage Low	V _{LO}			30%V _{DD}	V	
Output Enable Delay Time	T _{ON}			10	ms	
Output Disable Delay Time	T _{OFF}			200	ns	
Phase Jitter RMS				1	ps	12KHz~5MHz

Please kindly be noted that AKER DO NOT guarantee parts quality which involves human security application.

2 . C - MOS LOAD OUTPUT WAVEFORM

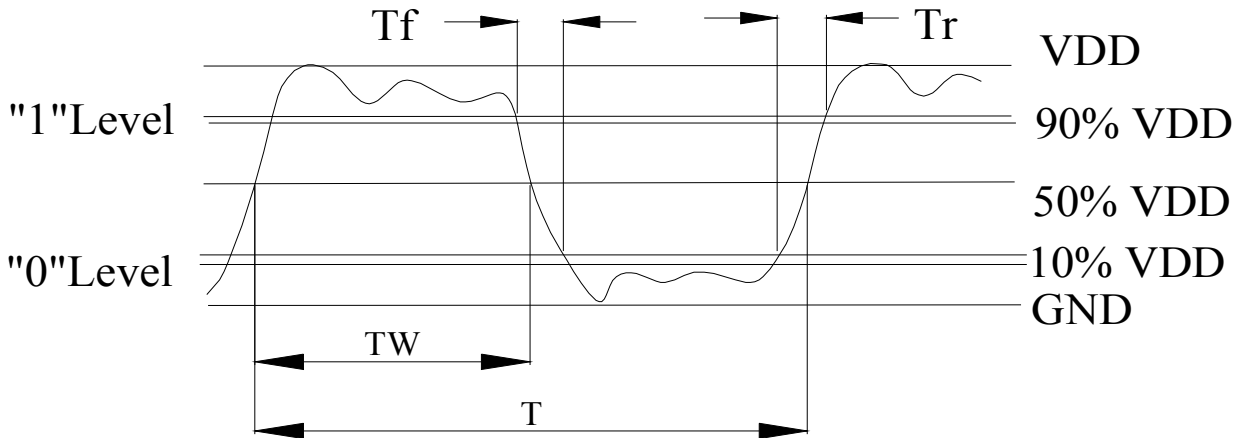

3 . C - MOS LOAD TEST CIRCUIT

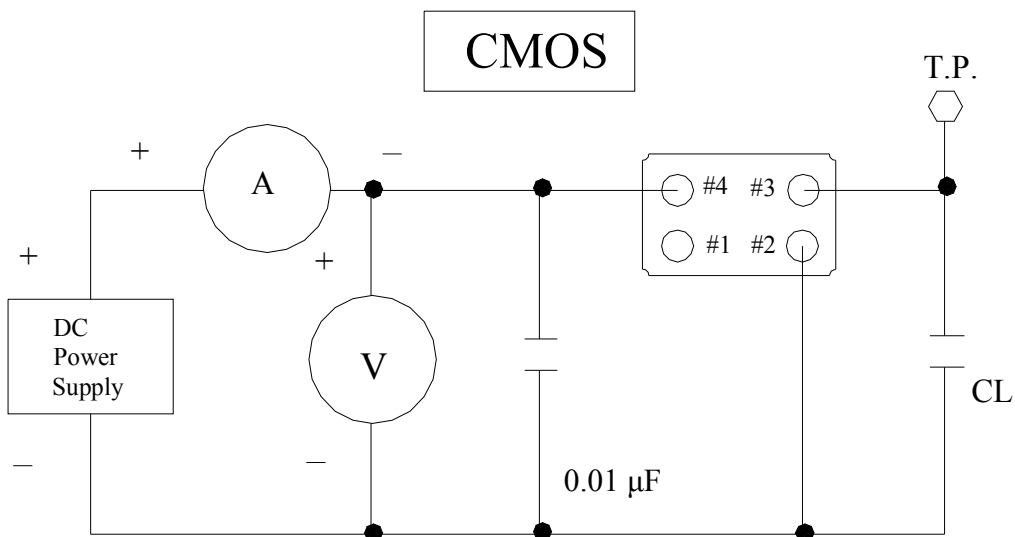

***Because SMA series has no by pass capacitor.
So,we recommend our customer to use capacitor 0.01 μ F
in join Vcc and GND.

4. MARKING :

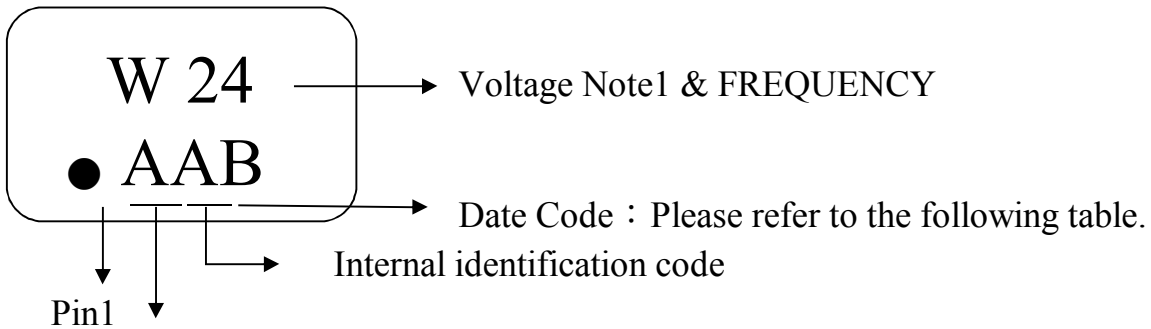

AKER LOGO.

NOTE1:

T	5.0V TTL
C	4.5~5.0V CMOS
L	2.97~3.63V TTL&CMOS
R	2.8~3.0V CMOS
S	2.25~2.75V CMOS
Y	1.5~2.0V CMOS
Z	0.8~1.4V CMOS
W	Voltage Range CMOS

Date Code Guide

Year	2021	2022	2023	2024
	2025	2026	2027	2028
Month	(4N+1)	(4N+2)	(4N+3)	(4N+0)
JAN	a	n	A	N
FEB	b	p	B	P
Mar	c	q	C	Q
Apr	d	r	D	R
May	e	s	E	S
Jun	f	t	F	T
Jul	g	u	G	U
Aug	h	v	H	V
Sep	j	w	J	W
Oct	k	x	K	X
Nov	l	y	L	Y
Dec	m	z	M	Z

A cycle every four years

5. DIMENSION :

(UNIT : mm)

Enable / Disable Function

E/D (#1)	OUTPUT (#3)
HIGH (Open)	Operating
LOW	High impedance

PIN FUNCTION

- #1 : Enable / Disable Control
- #2 : GND
- #3 : OUTPUT
- #4 : VDD

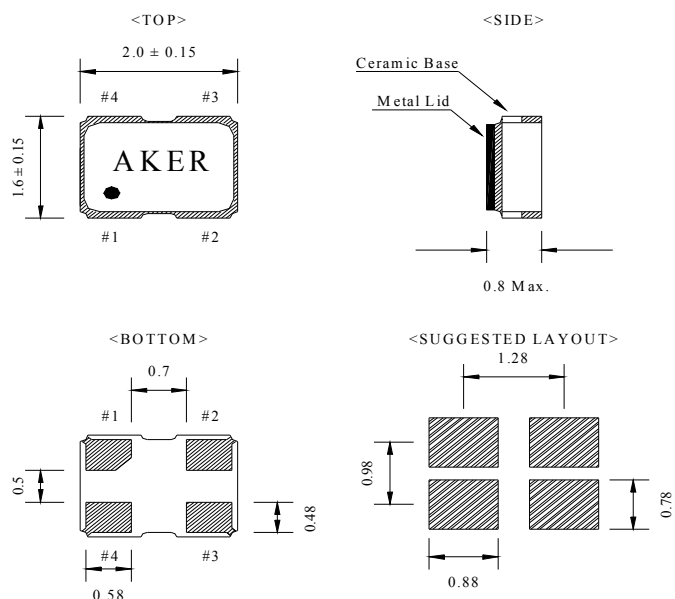

6 . STRUCTURE ILLUSTRATION

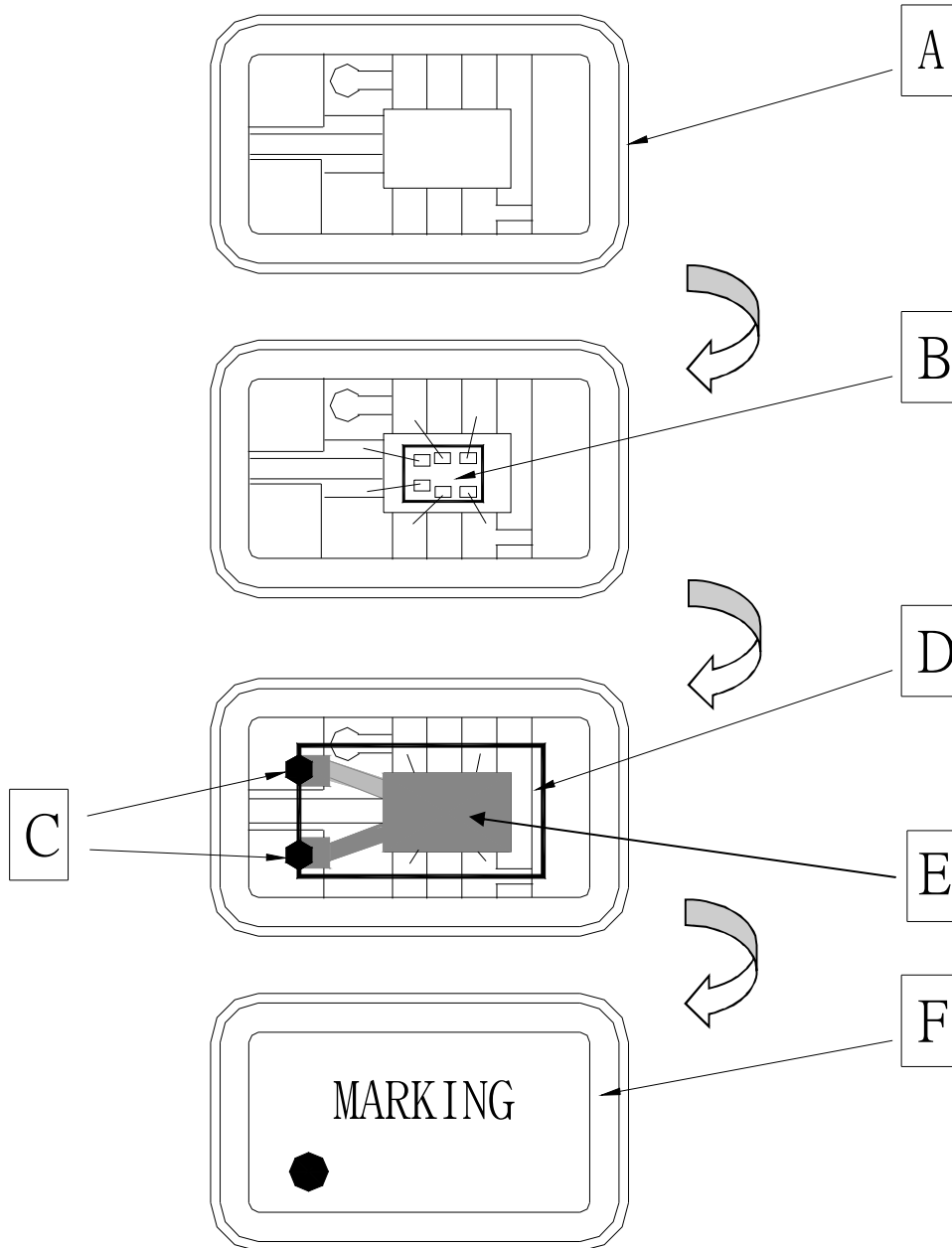

COMPONENTS		MATERIALS	COMPONENTS		MATERIALS
A	Base (Package)	Ceramic (Al ₂ O ₃)+Kovar (Fe/Co/Ni)	D	Crystal blank	SiO ₂
B	IC chip	-	E	Electrode	Cr / Ag
C	Conductive adhesive	Ag / Silicon resin	F	Lid	Fe/Co/Ni

7. PACKING :

TAPE SPECIFICATION

(Unit : mm)

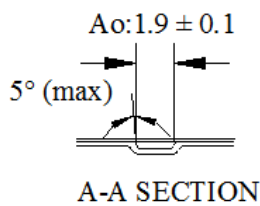
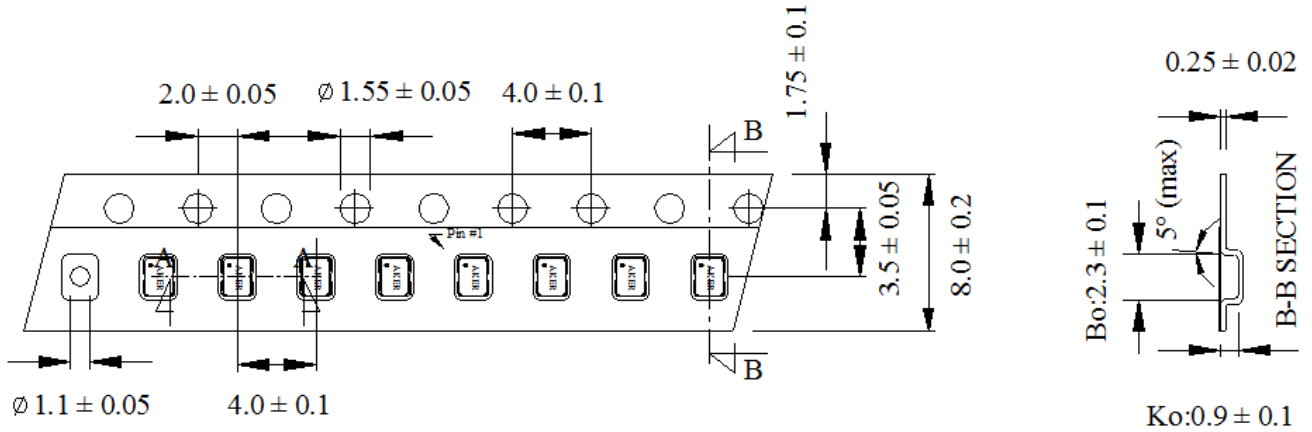

Feeding



OUTLINE DIMENSION

(Unit : mm)

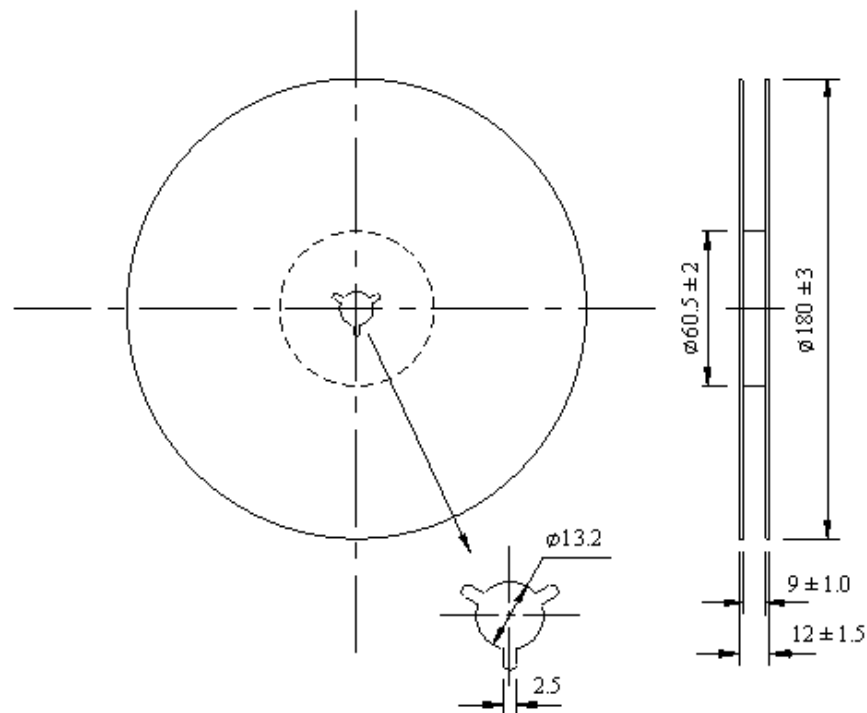

8. COVER TAPE ADHESION STRENGTH :

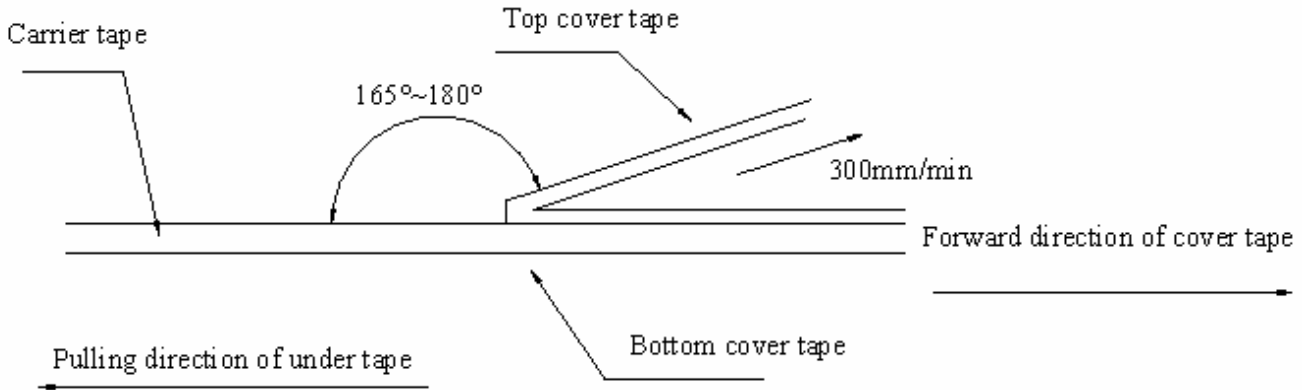

*** In the case, the cover tape is pulled off under the above conditions, the cover tape adhesion strength should be 10.2g~71.4g Plastic tape: 10.2g~71.4g

(Cover tape adhesion strength)

9. SOLDERING REFLOW PROFILE

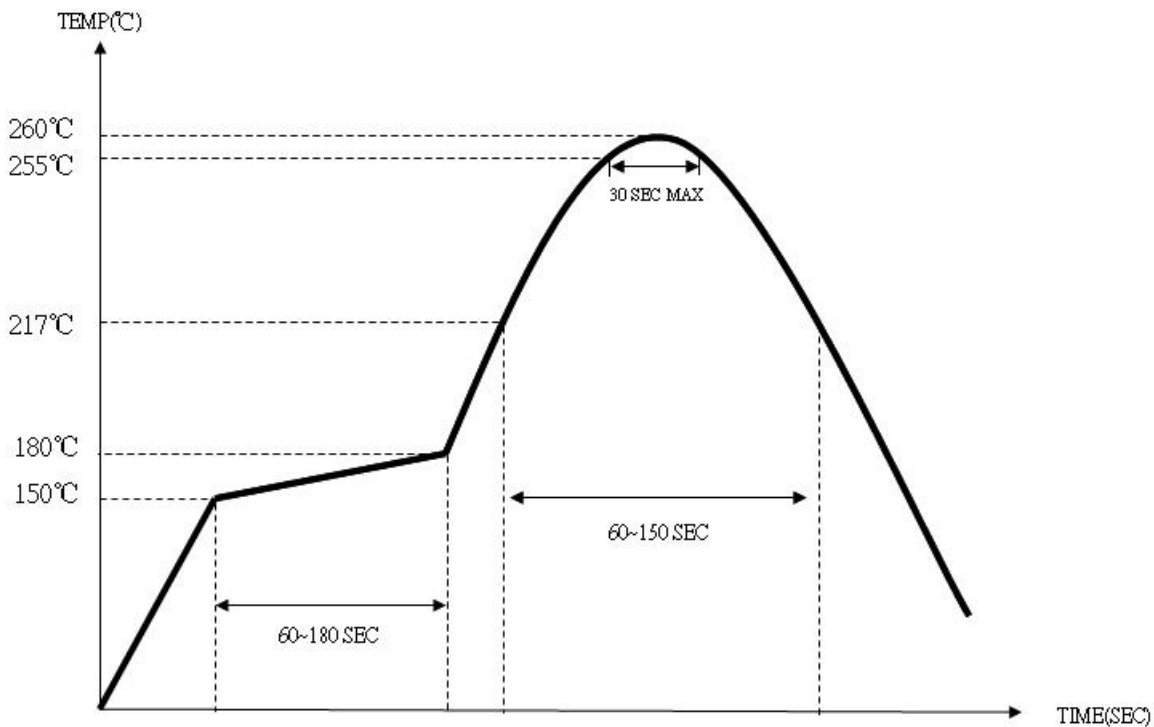

10. PACKING :

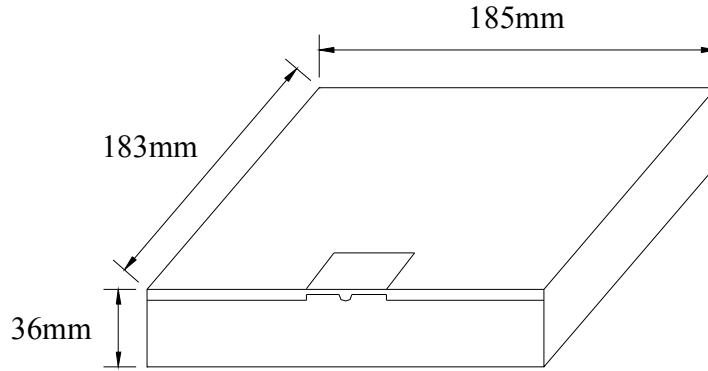

BOX = 3000 PCS / REEL(MAX)

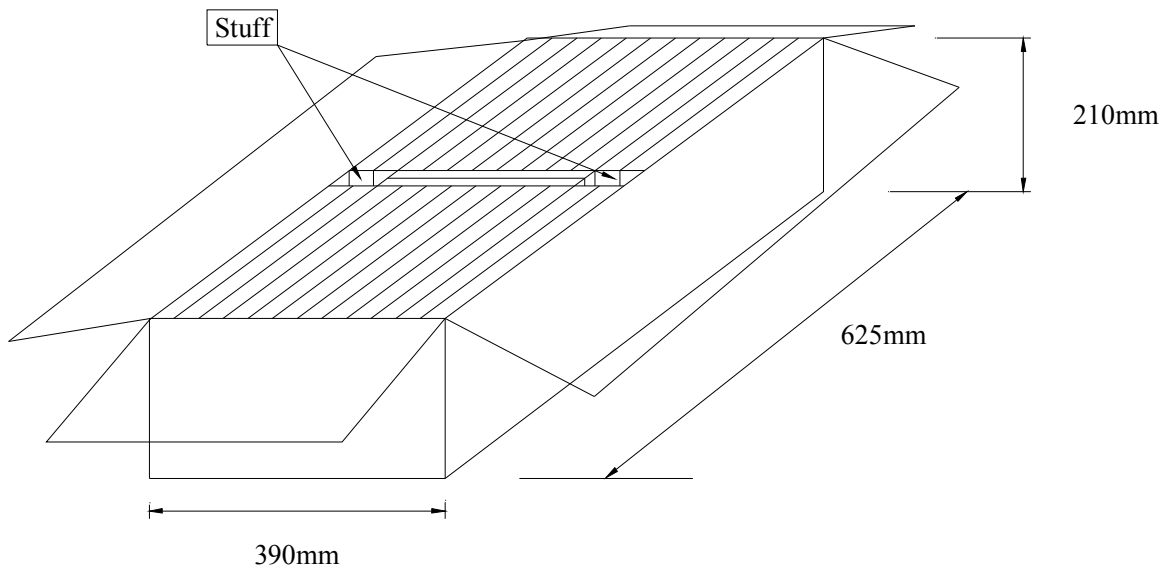

SMD product packs 32 BOX=The outside box packs (3000 PCS * 32 BOX = 96000 PCS)(MAX)



Aker Approved P/N :	SMAF-024576-A-D4-00	
APPROVED :	Xtal	SHEET : 9 of 9
PREPARED :	Xin	REV . : 1
Confidential		

11 . MECHANICAL PERFORMANCE

TEST ITEMS	TEST METHODS AND TEST CONDITION	PERFORMANCE
11.1 Temperature Cycling	-55±3°C /30min maximum~+125±3°C/30min maximum , 1000cycles	To satisfy the electrical performance .
11.2 Operational Life	125°C±3°C , 1000hrs±12hrs Rated VDD applied.	
11.3 Biased Humidity	85°C±5°C&85%±5%R.H. , 1000±12hrs Rated VDD applied.	
11.4 Resistance To Soldering Heat Test	Reflow test 2 times.	
11.5 High Temperature Exposure	150°C±3°C , 1000hrs±12hrs	
11.6 Vibration Test	Freq.range: 10~2000Hz , Peak to peak amplitude:1.52mm Peak acceleration:5G (49m/s ²) , 3 direction(X, Y,Z) , 20min 12cycles each of 3 orientations.	
11.7 Mechanical Shock	100G , 6mS , 3 times for each direction(X, Y, Z) , 3 cycles	
11.8 Physical Dimension	Verify physical dimensions to the applicable device detail specification.	
11.9 Solderability	260°C , Coated > 95%	
11.10 Board Flex	PCB=100*40(mm) , Bending=2 mm (min) , Duration=60+5/-0 sec	
11.11 External Visual	Inspect device construction and marking.	
11.12 Terminal Strength	A force of 17.7N for 60 seconds.	