

# APPROVAL SHEET

Customer Name : \_\_\_\_\_  
 Customer P/N : \_\_\_\_\_  
 Frequency : 37.125000 MHz  
 Aker Approved P/N : SMAF-037125-3-D4-00  
 Aker MPN : SMAF-037125-3-D4-00  
 Rev. : 1  
 ISSUE DATE : Feb.10.2023

APPROVED	CHECKED	PREPARED
<i>Leaf</i>		<i>Xin</i>
APPROVED BY CUSTOMER		

## AKER TECHNOLOGY CO., LTD.

ADDRESS : NO 11-3, Jianguo Rd., Tanzi Dist., Taichung City 427, Taiwan.

TEL : 886-4-25335978 FAX : 886-4-25336011

Web: [www.aker.com.tw](http://www.aker.com.tw)

**MSL:Level 1**

**RoHS Compliant**

**IATF 16949 Certified**

**AEC-Q200 Qualified**





Aker Approved P/N : SMAF-037125-3-D4-00	
APPROVED : Xtal	SHEET : 2 of 9
PREPARED : Xin	REV. : 1
Confidential	

## SMD CRYSTAL OSCILLATOR

### 1. ELECTRICAL CHARACTERISTICS

■ Standard atmospheric conditions

Unless otherwise specified , the standard range of atmospheric conditions for making measurement and tests are as follow :

Ambient temperature : 25±5°C

Relative humidity : 40%~70%

If there is any doubt about the results , measurement shall be made within the following limits :

Ambient temperature : 25±3°C

Relative humidity : 40%~70%

■ AKER Model : SMAF-321

■ Cutting Mode : AT CUT

Parameters	Symbol	Electrical Spec				Notes
		Min.	Typ.	Max.	Units.	
Nominal Frequency		37.125000			MHz	
Frequency Stability		±50			ppm	
Supply Voltage	V <sub>CC</sub>	3.3±10%			V	
Output Load CMOS	CL			15	pF	
Aging		±3			ppm	First Year
Enable Control		Yes				Pad 1
Operating Temperature		-40	25	85	°C	
Storage Temperature Range		-55	~	150	°C	
Output Voltage High	VoH	90%V <sub>DD</sub>			V	
Output Voltage Low	VoL			10%V <sub>DD</sub>	V	
Input Current	I <sub>CC</sub>			20	mA	
Standby Current	I <sub>ST</sub>			10	μA	
Rise Time	Tr			5	ns	10%~90%V <sub>DD</sub> Level
Fall Time	Tf			5	ns	90%~10%V <sub>DD</sub> Level
Symmetry (Duty ratio)	TH/T	45	~	55	%	
Start-up Time	T <sub>osc</sub>			10	ms	
Enable Voltage High	V <sub>hi</sub>	70%V <sub>DD</sub>			V	
Disable Voltage Low	V <sub>lo</sub>			30%V <sub>DD</sub>	V	
Output Enable Delay Time	T <sub>on</sub>			10	ms	
Output Disable Delay Time	T <sub>off</sub>			200	ns	
Phase Jitter RMS				1	ps	12KHz~5MHz

\*Please kindly be noted that AKER DO NOT guarantee parts quality which involves human security application.\*

## 2 . C - MOS LOAD OUTPUT WAVEFORM

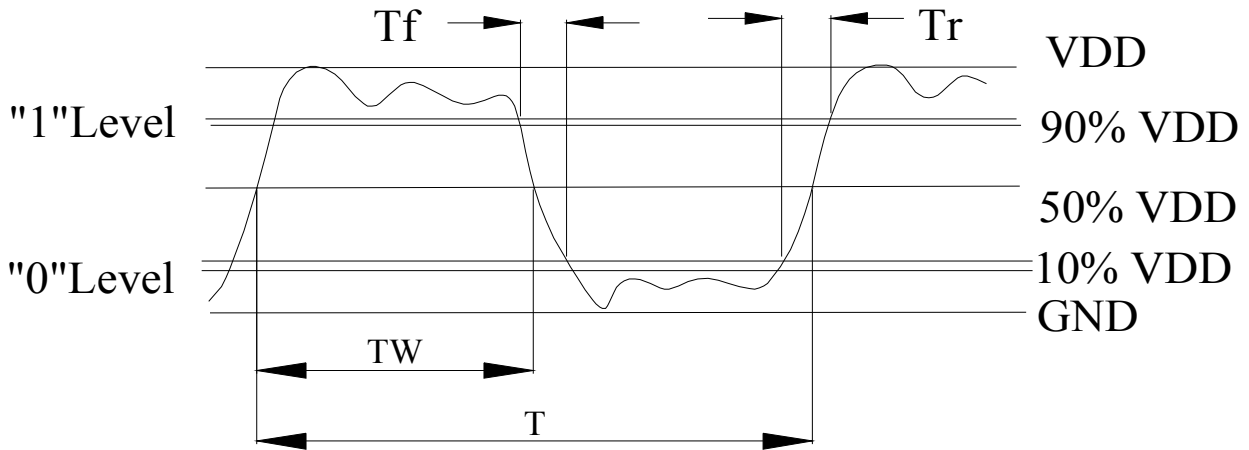

## 3 . C - MOS LOAD TEST CIRCUIT

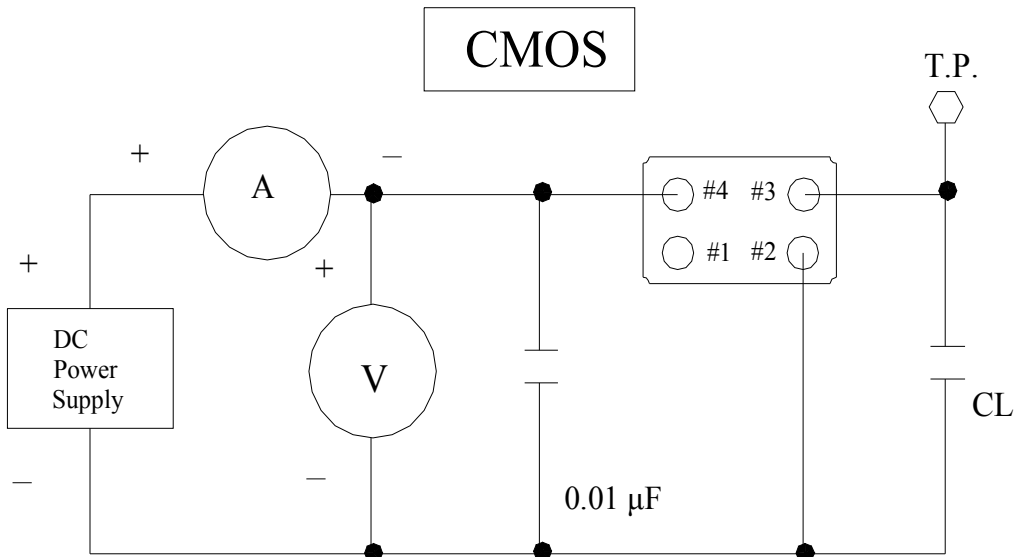

\*\*\*Because SMA series has no by pass capacitor.  
So,we recommend our customer to use capacitor 0.01  $\mu\text{F}$   
in join Vcc and GND.

#### 4. MARKING :

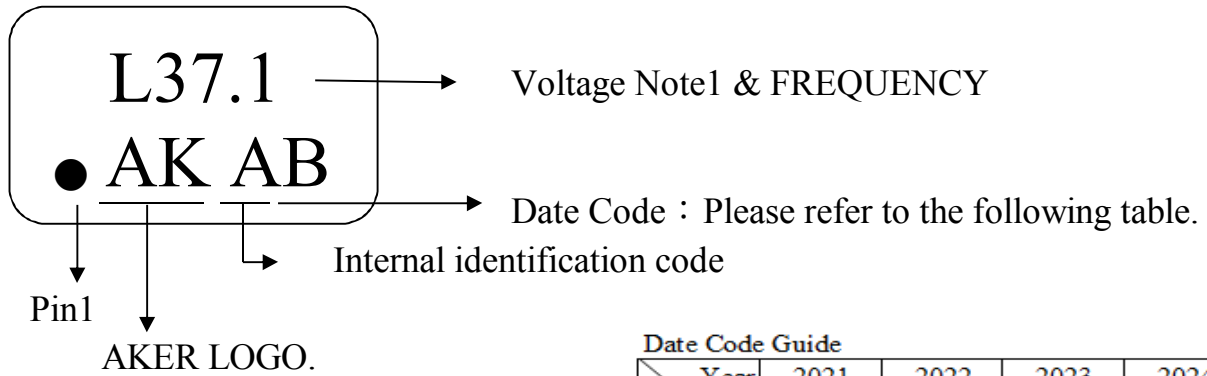

NOTE1:

T	5.0V TTL
C	4.5~5.0V CMOS
L	2.97~3.63V TTL&CMOS
R	2.8~3.0V CMOS
S	2.25~2.75V CMOS
Y	1.5~2.0V CMOS
Z	0.8~1.4V CMOS
W	Voltage Range CMOS

Date Code Guide

Year	2021	2022	2023	2024
	2025	2026	2027	2028
Month	(4N+1)	(4N+2)	(4N+3)	(4N+0)
JAN	a	n	A	N
FEB	b	p	B	P
Mar	c	q	C	Q
Apr	d	r	D	R
May	e	s	E	S
Jun	f	t	F	T
Jul	g	u	G	U
Aug	h	v	H	V
Sep	j	w	J	W
Oct	k	x	K	X
Nov	l	y	L	Y
Dec	m	z	M	Z

A cycle every four years

#### 5. DIMENSION :

( UNIT : mm )

##### Enable / Disable Function

E/D (#1)	OUTPUT (#3)
HIGH (Open)	Operating
LOW	High impedance

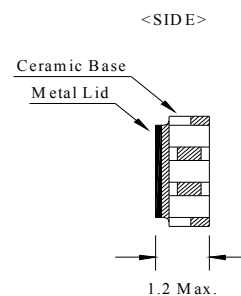
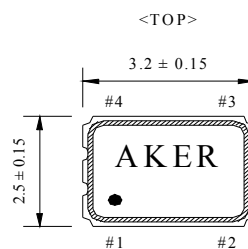

##### PIN FUNCTION

- #1 : Enable / Disable Control
- #2 : GND
- #3 : OUTPUT
- #4 : VDD

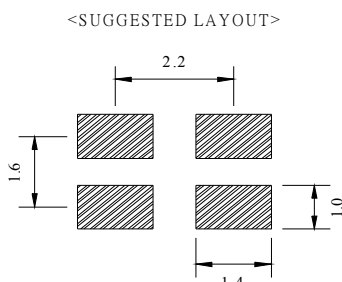
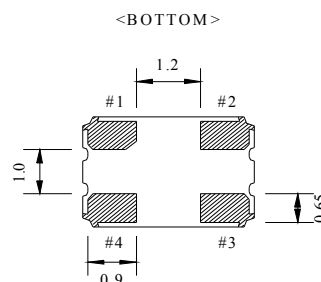

## 6 . STRUCTURE ILLUSTRATION

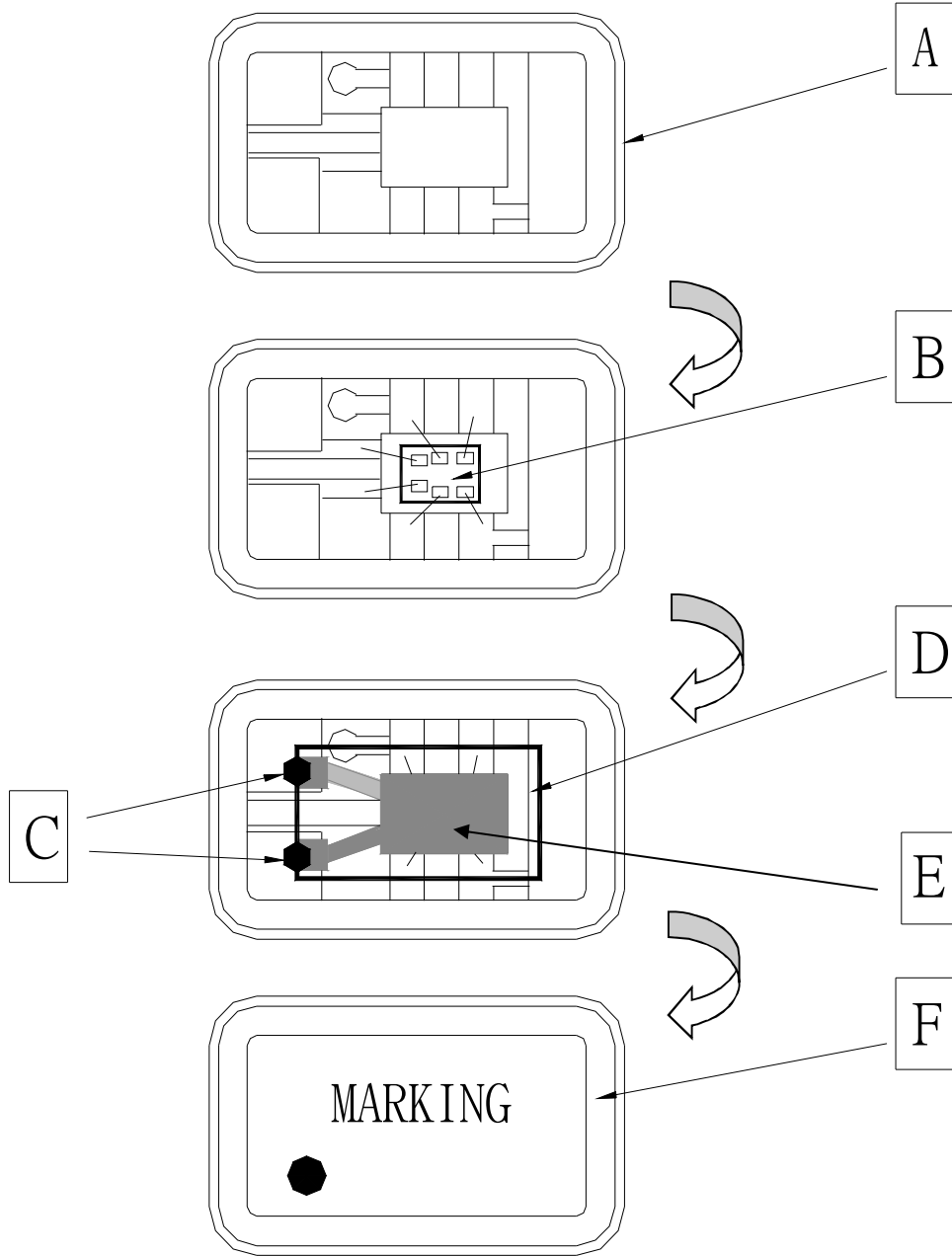

COMPONENTS		MATERIALS		COMPONENTS		MATERIALS	
A	Base (Package)	Ceramic (Al <sub>2</sub> O <sub>3</sub> )+Kovar (Fe/Co/Ni)		D	Crystal blank	SiO <sub>2</sub>	
B	IC chip	-		E	Electrode	Cr / Ag	
C	Conductive adhesive	Ag / Silicon resin		F	Lid	Fe/Co/Ni	

## 7. PACKING :

### TAPE SPECIFICATION

( Unit : mm )

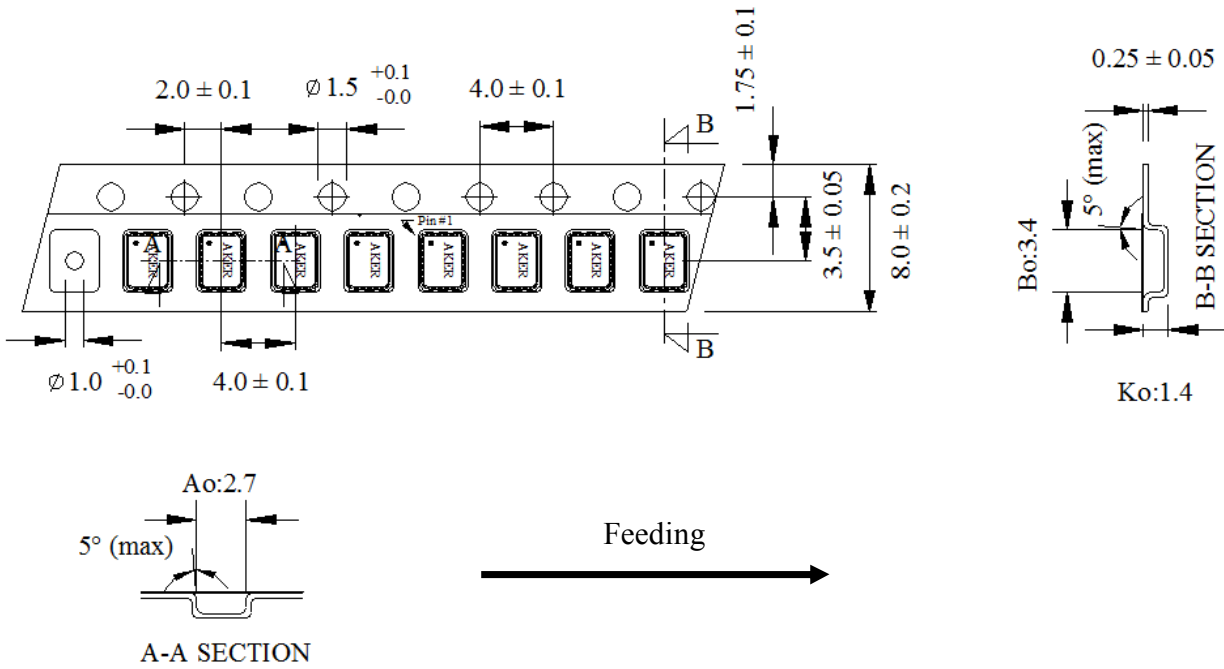

### OUTLINE DIMENSION

( Unit : mm )

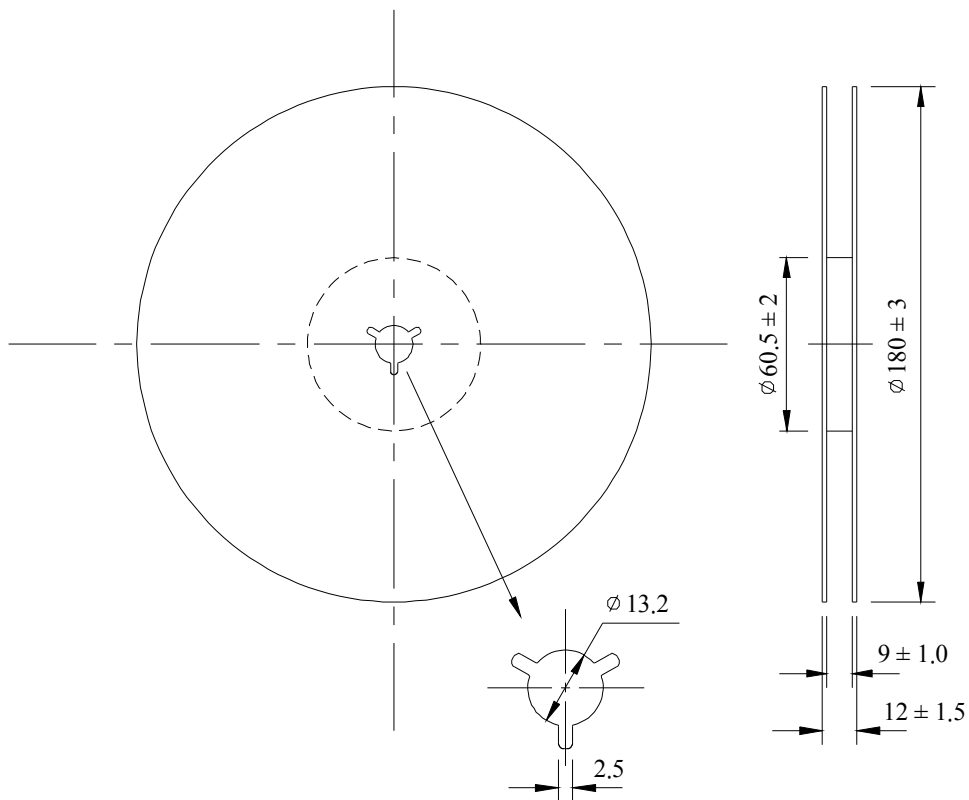

### 8. COVER TAPE ADHESION STRENGTH :

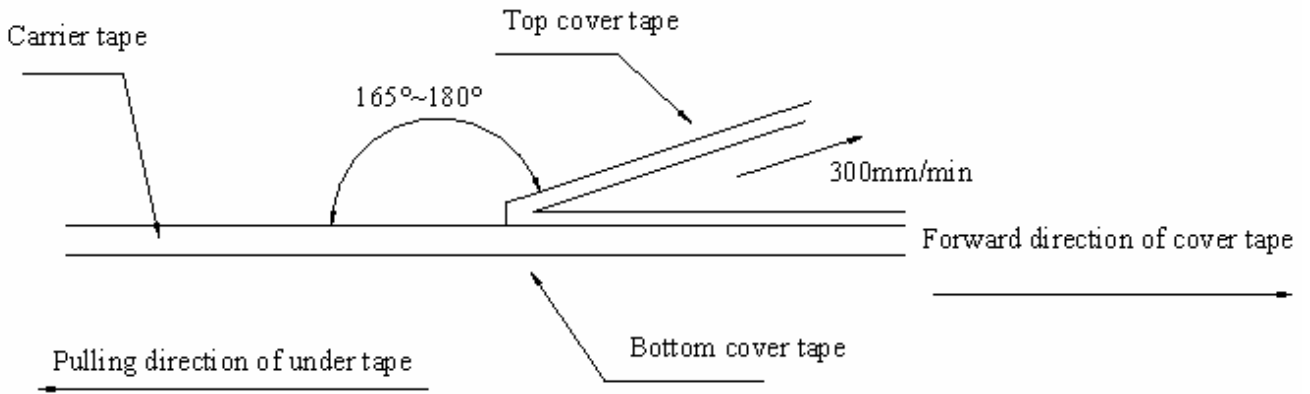

\*\*\* In the case, the cover tape is pulled off under the above conditions, the cover tape adhesion strength should be 10.2g~71.4g

Plastic tape: 10.2g~71.4g

(Cover tape adhesion strength)

### 9. SOLDERING REFLOW PROFILE

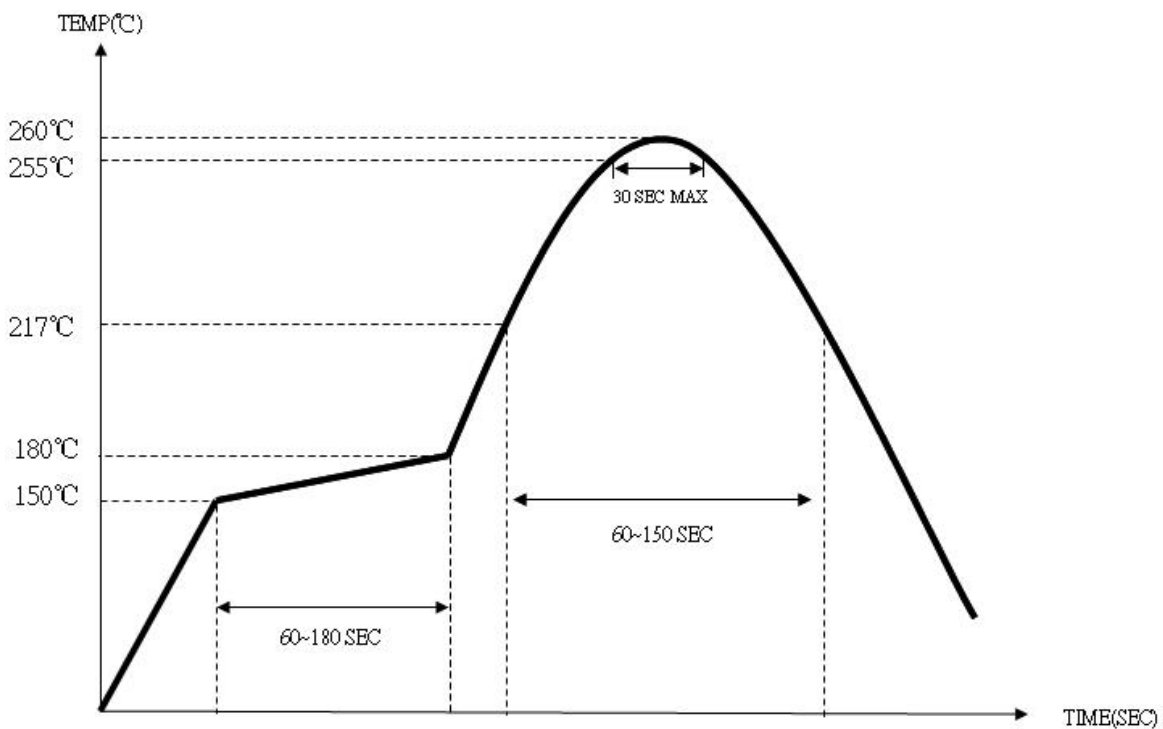



**10. PACKING :**

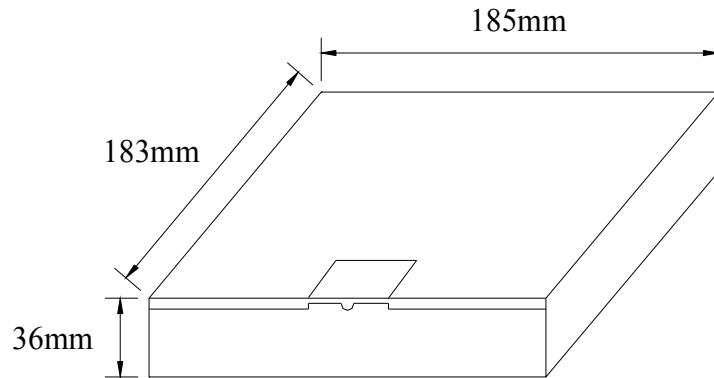

BOX = 3000 PCS / REEL(MAX)

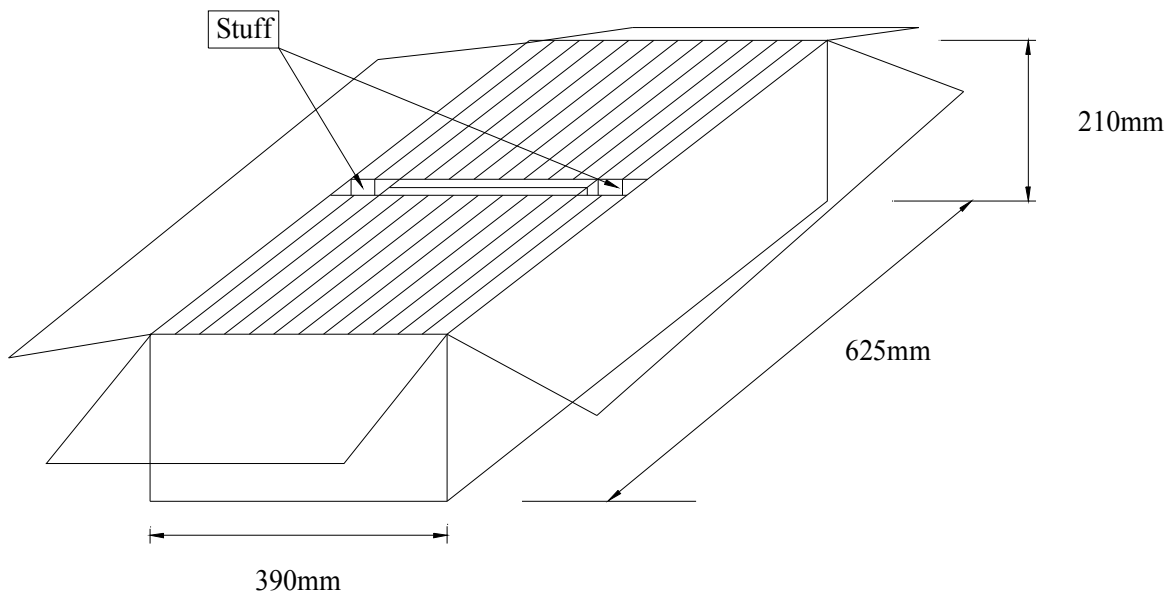

SMD product packs 32 BOX=The outside box packs (3000 PCS \* 32 BOX = 96000 PCS)(MAX)



Aker Approved P/N : SMAF-037125-3-D4-00

APPROVED : Xtal SHEET : 9 of 9

PREPARED : Xin REV. : 1

Confidential

## 11 . MECHANICAL PERFORMANCE

TEST ITEMS	TEST METHODS AND TEST CONDITION	PERFORMANCE
11.1 Temperature Cycling	-55±3°C/30min maximum~+125±3°C/30min maximum , 1000cycles	To satisfy the electrical performance .
11.2 Operational Life	125°C±3°C , 1000hrs±12hrs	
11.3 Biased Humidity	85°C±5°C&85%±5%R.H. , 1000±12hrs	
11.4 Resistance To Soldering Heat Test	Reflow test 2 times.	
11.5 High Temperature Exposure	150°C±3°C , 1000hrs±12hrs	
11.6 Vibration Test	Freq.range: 10~2000Hz , Peak to peak amplitude:1.52mm Peak acceleration:5G (49m/s <sup>2</sup> ) , 3 direction(X, Y,Z) , 20min 12cycles each of 3 orientations.	
11.7 Mechanical Shock	100G , 6mS , 3 times for each direction(X, Y, Z ) , 3 cycles	
11.8 Physical Dimension	Verify physical dimensions to the applicable device detail specification.	
11.9 Solderability	260°C , Coated > 95%	
11.10 Board Flex	PCB=100*40(mm) , Bending=2 mm (min) , Duration=60+5/-0 sec	
11.11 External Visual	Inspect device construction and marking.	
11.12 Terminal Strength	A force of 17.7N for 60 seconds.	