



# US1A THRU US1M

Reverse Voltage - 50 to 1000 Volts Forward Current - 1.0 Ampere

## SURFACE MOUNT ULTRA FAST RECTIFIER

### Features

- ◆ The plastic package carries Underwriters Laboratory Flammability Classification 94V-0
- ◆ For surface mounted applications
- ◆ Ultra fast switching for high efficiency
- ◆ Low reverse leakage
- ◆ Built-in strain relief, ideal for automated placement
- ◆ High forward surge current capability
- ◆ High temperature soldering guaranteed  
250 °C/10 seconds at terminals

DO-214AC/SMA

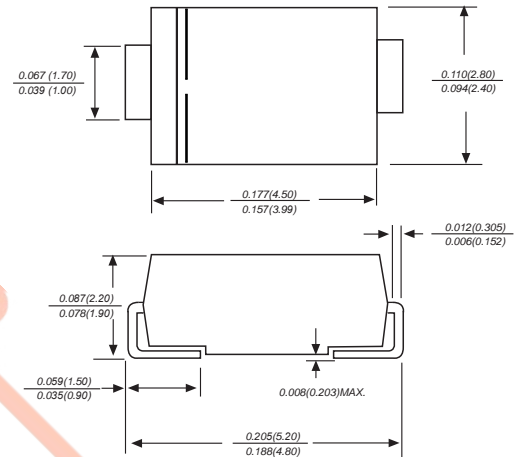

Dimensions in inches and (millimeters)

### Mechanical Data

- Case :** JEDEC DO-214AC/SMA Molded plastic body  
**Terminals :** Solder plated, solderable per MIL-STD-750, Method 2026  
**Polarity :** Polarity symbol marking on body  
**Mounting Position :** Any  
**Weight :** 0.002 ounce, 0.07 grams

### Maximum Ratings And Electrical Characteristics

Ratings at 25°C ambient temperature unless otherwise specified.

Single phase half-wave 60Hz, resistive or inductive load, for capacitive load current derate by 20%.

Parameter	SYMBOLS	US1A	US1B	US1D	US1G	US1J	US1K	US1M	UNITS
		MDD US1A	MDD US1B	MDD US1D	MDD US1G	MDD US1J	MDD US1K	MDD US1M	
Maximum repetitive peak reverse voltage	$V_{RRM}$	50	100	200	400	600	800	1000	V
Maximum RMS voltage	$V_{RMS}$	35	70	140	280	420	560	700	V
Maximum DC blocking voltage	$V_{DC}$	50	100	200	400	600	800	1000	V
Maximum average forward rectified current at $T_L=55^\circ\text{C}$	$I_{(AV)}$	1.0							A
Peak forward surge current 8.3ms single half sine-wave superimposed on rated load (JEDEC Method)	$I_{FSM}$	30							A
Maximum instantaneous forward voltage at 1.0A	$V_F$	1.0		1.30		1.70		V	
Maximum DC reverse current $T_A=25^\circ\text{C}$ at rated DC blocking voltage $T_A=125^\circ\text{C}$	$I_R$	5 50							$\mu\text{A}$
Maximum reverse recovery time (NOTE 1)	$t_{rr}$	50				75			ns
Typical junction capacitance (NOTE 2)	$C_J$	15.0							pF
Typical thermal resistance (NOTE 3)	$R_{\theta JA}$	50.0							$^\circ\text{C}/\text{W}$
Operating junction and storage temperature range	$T_J, T_{STG}$	-50 to +150							$^\circ\text{C}$

- Note:** 1. Reverse recovery condition  $I_F=0.5\text{A}, I_R=1.0\text{A}, t_{rr}=0.25\text{A}$   
 2. P.C.B. mounted with 2.0x2.0" (5.0x5.0cm) copper pad areas.  
 3. Measured at 1MHz and applied reverse voltage of 4.0V D.C.



# US1A THRU US1M

Reverse Voltage - 50 to 1000 Volts Forward Current - 1.0 Ampere

## Ratings And Characteristic Curves

AVERAGE FORWARD RECTIFIED CURRENT, AMPERES

FIG. 1- FORWARD CURRENT DERATING CURVE

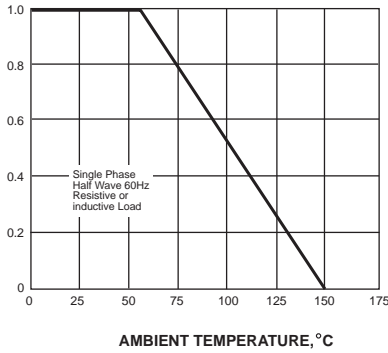

PEAK FORWARD SURGE CURRENT, AMPERES

FIG. 2-MAXIMUM NON-REPETITIVE PEAK FORWARD SURGE CURRENT

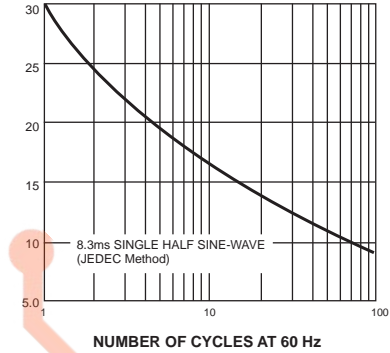
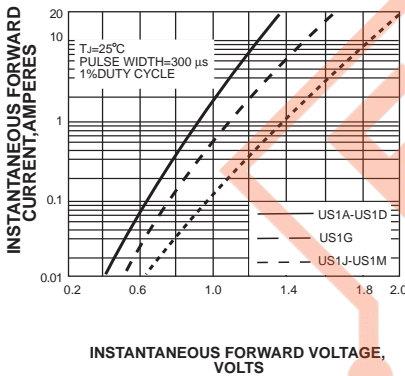

FIG. 3-TYPICAL INSTANTANEOUS FORWARD CHARACTERISTICS



INSTANTANEOUS REVERSE CURRENT, MICROAMPERES

FIG. 4-TYPICAL REVERSE CHARACTERISTICS

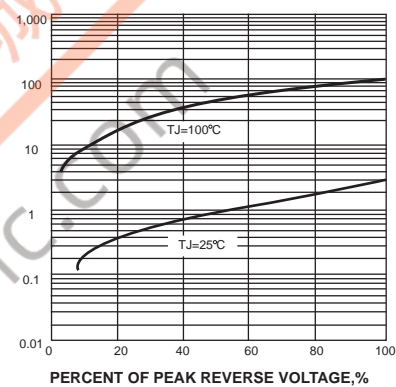
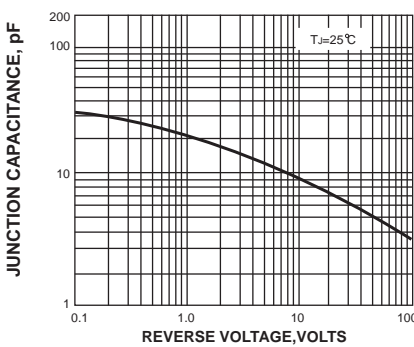
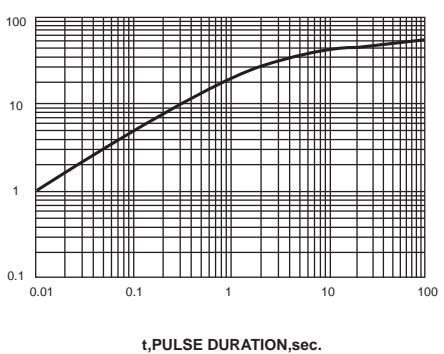

FIG. 5-TYPICAL JUNCTION CAPACITANCE



TRANSIENT THERMAL IMPEDANCE, °C/W

FIG. 6-TYPICAL TRANSIENT THERMAL IMPEDANCE



The curve above is for reference only.



# US1A THRU US1M

Reverse Voltage - 50 to 1000 Volts Forward Current - 1.0 Ampere

## Packing information

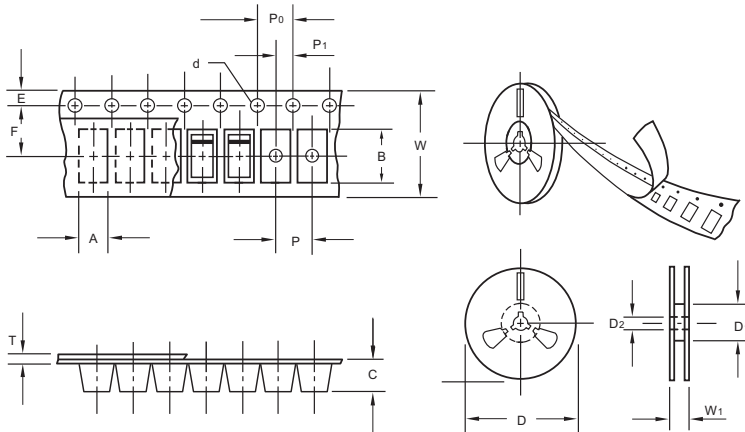

unit:mm

Item	Symbol	Tolerance	SMA
Carrier width	A	0.1	2.80
Carrier length	B	0.1	5.33
Carrier depth	C	0.1	2.36
Sprocket hole	d	0.05	1.50
13" Reel outside diameter	D	2.0	330.00
13" Reel inner diameter	D <sub>1</sub>	min	50.00
7" Reel outside diameter	D	2.0	178.00
7" Reel inner diameter	D <sub>1</sub>	min	62.00
Feed hole diameter	D <sub>2</sub>	0.5	13.00
Sprocket hole position	E	0.1	1.75
Punch hole position	F	0.1	5.50
Punch hole pitch	P	0.1	4.00
Sprocket hole pitch	P <sub>0</sub>	0.1	4.00
Embossment center	P <sub>1</sub>	0.1	2.00
Overall tape thickness	T	0.1	0.28
Tape width	W	0.3	12.00
Reel width	W <sub>1</sub>	1.0	18.00

Note: Devices are packed in accordance with EIA standard RS-481-A and specifications listed above.

## Reel packing

PACKAGE	REEL SIZE	REEL (pcs)	COMPONENT SPACING (m/m)	BOX (pcs)	INNER BOX (m/m)	REEL DIA. (m/m)	CARTON SIZE (m/m)	CARTON (pcs)	APPROX. GROSS WEIGHT (kg)
SMA	7"	2,000	4.0	4,000	183*155*183	178	382*356*392	160,000	16.0
SMA	11"	5,000	4.0	10,000	290*290*38	330	310*310*360	80,000	11.0
SMA	13"	7,500	4.0	15,000	335*335*38	330	350*330*360	120,000	14.5

## Suggested Pad Layout

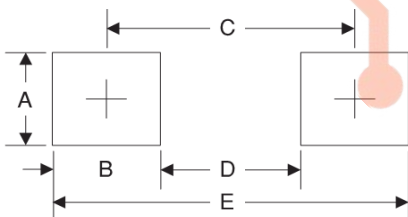

Symbol	Unit (mm)	Unit (inch)
A	1.68	0.066
B	1.52	0.060
C	3.90	0.154
D	2.41	0.095
E	5.45	0.215

## Important Notice and Disclaimer

Microdiode Electronics (Jiangsu) reserves the right to make changes to this document and its products and specifications at any time without notice. Customers should obtain and confirm the latest product information and specifications before final design, purchase or use.

Microdiode Electronics (Jiangsu) makes no warranty, representation or guarantee regarding the suitability of its products for any particular purpose, nor does Microdiode Electronics (Jiangsu) assume any liability for application assistance or customer product design. Microdiode Electronics (Jiangsu) does not warrant or accept any liability with products which are purchased or used for any unintended or unauthorized application.

No license is granted by implication or otherwise under any intellectual property rights of Microdiode Electronics (Jiangsu).

Microdiode Electronics (Jiangsu) products are not authorized for use as critical components in life support devices or systems without express written approval of Microdiode Electronics (Jiangsu).